

**ESTORES ENROLLABLES  
Y MOTORIZADOS**  
GUÍA DE INSTALACIÓN

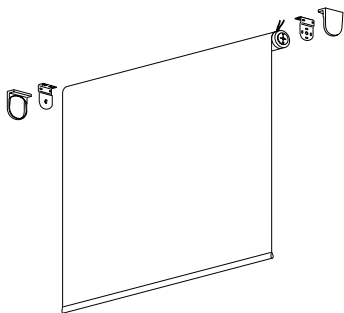

1.

## ESTORES ENROLLABLES

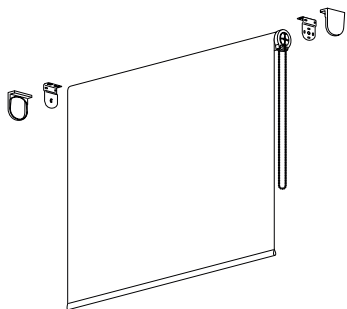
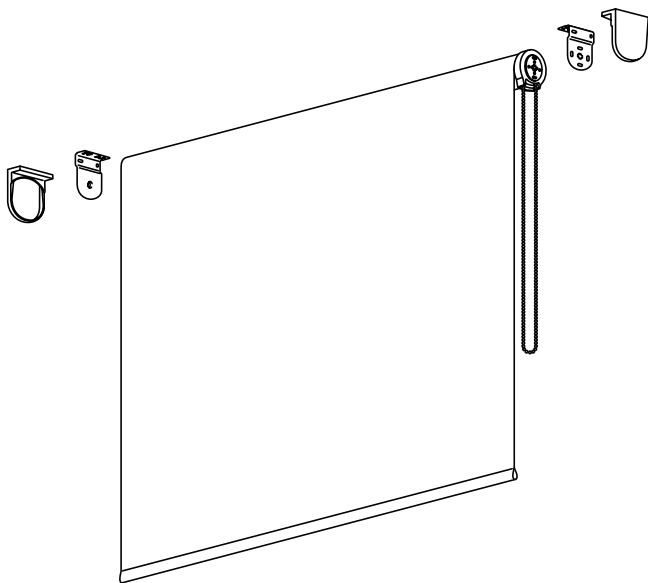

# Comprobamos las piezas

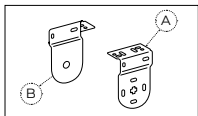

**Soporte A  
Soporte B**

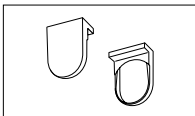

**Embellecedores**

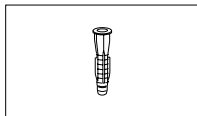

**Tacos\***

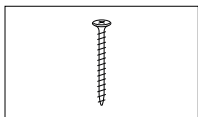

**Tornillos\***

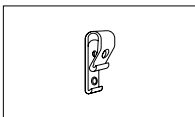

**Seguridad niños**

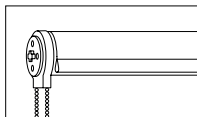

**Estor**

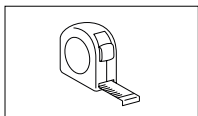

**Cinta métrica**

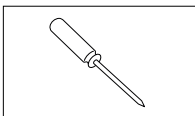

**Destornillador  
de estrella**

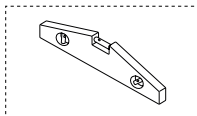

**Nivel  
instalación a pared**

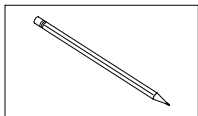

**Lápiz**

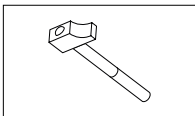

**Martillo**

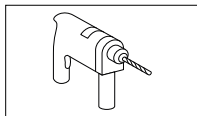

**Taladro**

*\*Si la instalación se va a realizar en alguna superficie que no sea ladrillo, es recomendable adquirir alguna tornillería específica.*

# 1| Ubicamos el soporte A

## INSTALACIÓN A PARED

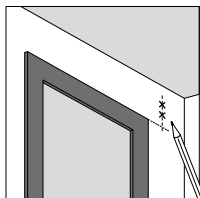

Medir y marcar

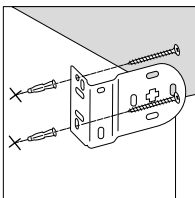

Fijar

## INSTALACIÓN A TECHO

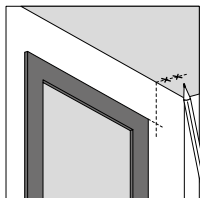

Medir y marcar

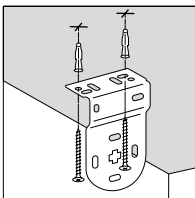

Fijar

---

El primer soporte que colocaremos será el **soporte A**. Este soporte se coloca **en el lado donde queramos el mecanismo** (cadenilla o motor).

Con el metro, medimos y marcamos su ubicación.

Taladramos, colocamos los tacos y fijamos el soporte.

## 2 | Ubicamos el soporte B

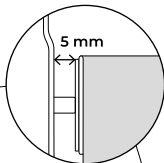

### INSTALACIÓN A PARED

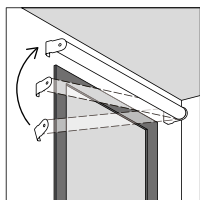

Colocar

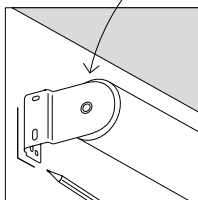

Marcar

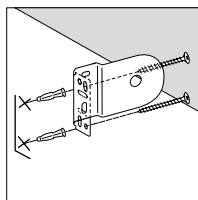

Fijar

### INSTALACIÓN A TECHO

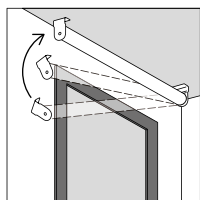

Colocar

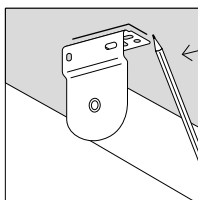

Marcar

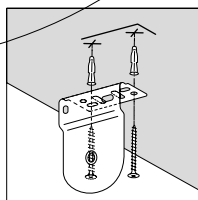

Fijar

Introducimos el estor en el **soporte A** ya colocado y calculamos donde se ubicará el soporte B, **dejando medio centímetro** entre el **soporte B** y el estor **como en el dibujo**. Marcamos su ubicación con un lápiz, quitamos el estor, taladramos, colocamos los tacos y fijamos el soporte B. Es recomendable usar el nivel para la instalación a pared.

### 3 | Colocamos los embellecedores

#### INSTALACIÓN A PARED

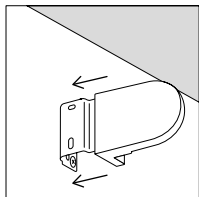

Soporte B

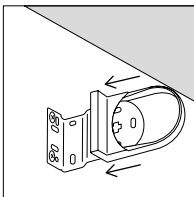

Soporte A

#### INSTALACIÓN A TECHO

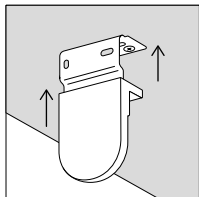

Soporte B

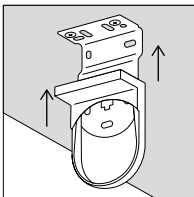

Soporte A

## 4 | Fijamos el enrollable

### INSTALACIÓN A PARED

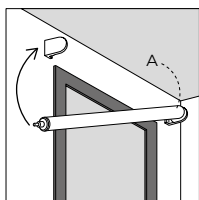

Colocar

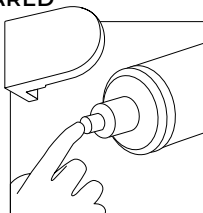

Presionar

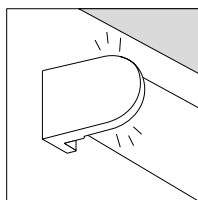

Clic

### INSTALACIÓN A TECHO

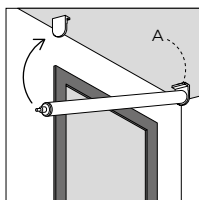

Colocar

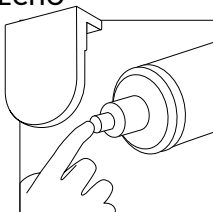

Presionar

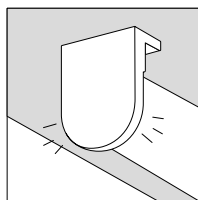

Clic

---

Introducimos el extremo del estor que lleva el accionamiento (cadenilla o motor) en el **soporte A**. A continuación, presionamos el otro extremo del estor para fijarlo en el **soporte B** hasta que haga «clic».

## 5 | Seguridad niños

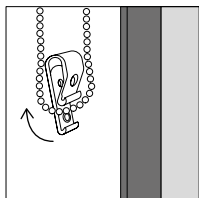

Colocar

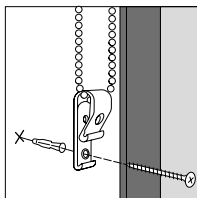

Taladrar y atornillar

*La seguridad niños se atornilla a la pared. De esta manera, los niños no podrán jugar con la cadenilla, evitando posibles accidentes.*

### ADVERTENCIA

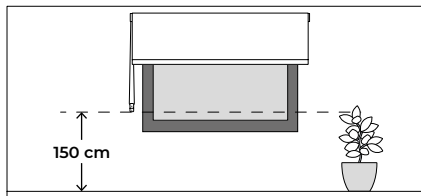

Medir



*La altura de la cadena debe quedar instalada como mínimo a 150 cm del suelo.*

---

Introducimos la cadenilla en la seguridad niños y marcamos la ubicación. Taladramos, colocamos los tacos y fijamos la pieza.



2.

## ESTORES ENROLLABLES MOTORIZADOS

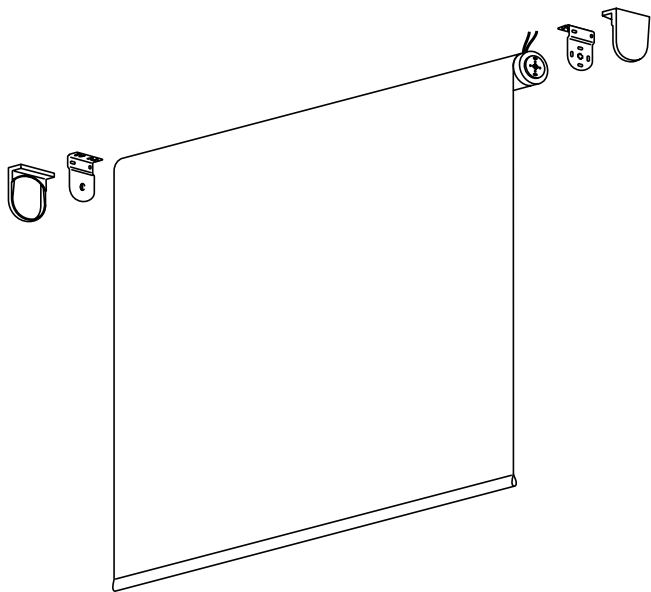

# Comprobar piezas

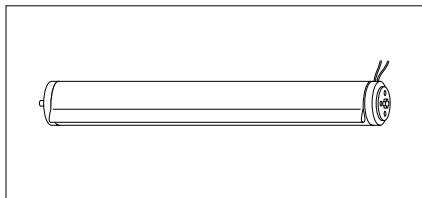

**Estor**

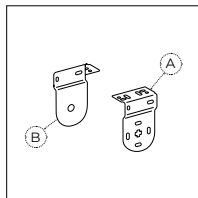

**Soporte A  
Soporte B**

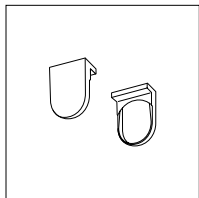

**Embellecedores**

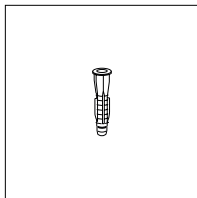

**Tacos\***

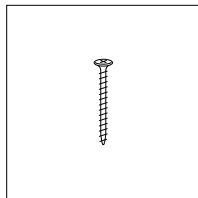

**Tornillos\***

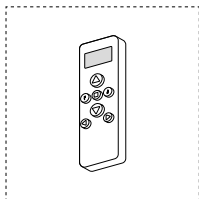

**Mando**  
(opcional)

*\*Si la instalación se va a realizar en alguna superficie que no sea ladrillo, es recomendable adquirir alguna tornillería específica.*

# Necesitamos

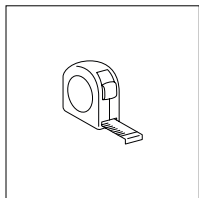

**Cinta métrica**

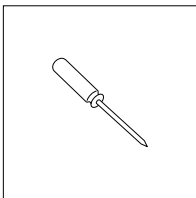

**Destornillador  
de estrella**

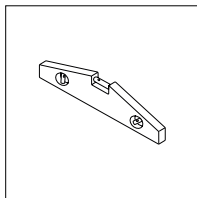

**Nivel  
instalación a pared**

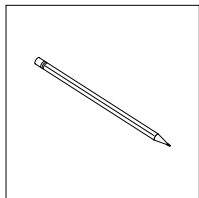

**Lápiz**

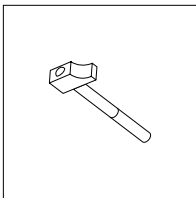

**Martillo**

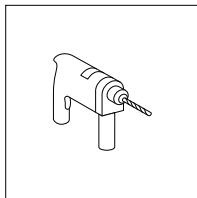

**Taladro**

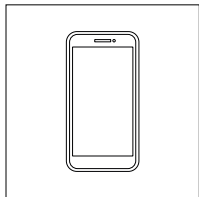

**Teléfono móvil**

# 1| Ubicamos el soporte A

## INSTALACIÓN A PARED

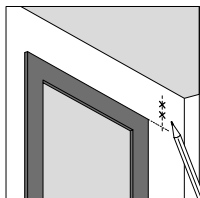

Medir y marcar

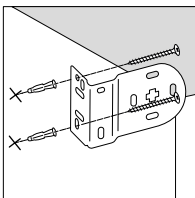

Fijar

## INSTALACIÓN A TECHO

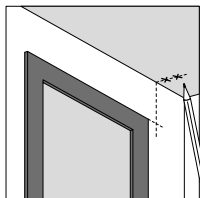

Medir y marcar

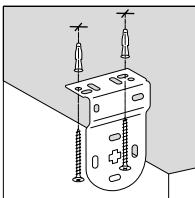

Fijar

---

El primer soporte que colocaremos será el **soporte A**. Este soporte se coloca **en el lado donde queramos el mecanismo** (motor). Con el metro, medimos y marcamos su ubicación. Taladramos, colocamos los tacos y fijamos el soporte.

## 2 | Ubicamos el soporte B

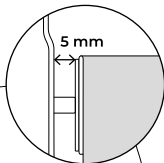

### INSTALACIÓN A PARED

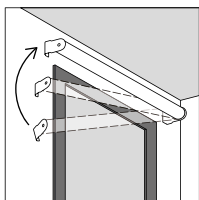

Colocar

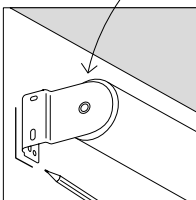

Marcar

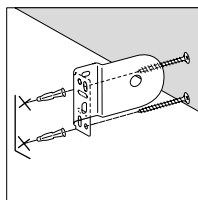

Fijar

### INSTALACIÓN A TECHO

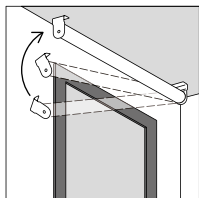

Colocar

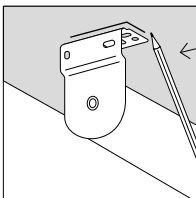

Marcar

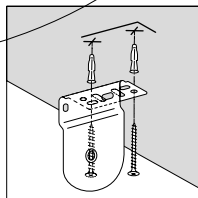

Fijar

Introducimos el estor en el **soporte A** ya colocado y calculamos donde se ubicará el soporte B, **dejando medio centímetro** entre el **soporte B** y el estor **como en el dibujo**. Marcamos su ubicación con un lápiz, quitamos el estor, taladramos, colocamos los tacos y fijamos el soporte B. Es recomendable usar el nivel para la instalación a pared.

### 3 | Colocamos los embellecedores

#### INSTALACIÓN A PARED

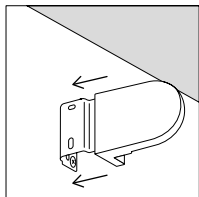

Soporte B

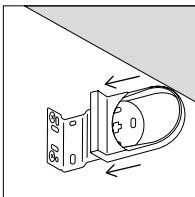

Soporte A

#### INSTALACIÓN A TECHO

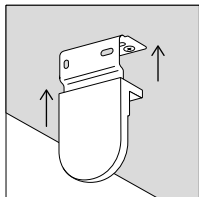

Soporte B

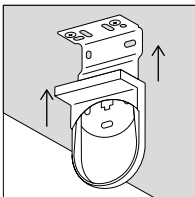

Soporte A

## 4 | Fijamos el enrollable

### INSTALACIÓN A PARED

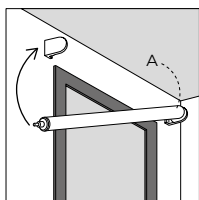

Colocar

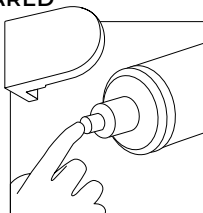

Presionar

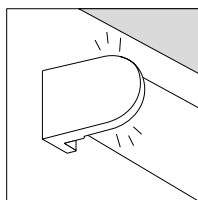

Clic

### INSTALACIÓN A TECHO

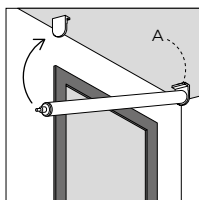

Colocar

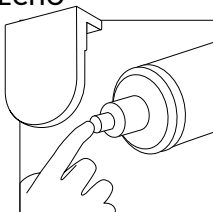

Presionar

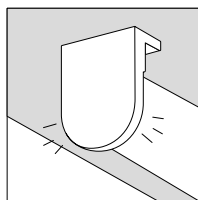

Clic

---

Introducimos el extremo del estor que lleva el accionamiento (cadenilla o motor) en el **soporte A**. A continuación, presionamos el otro extremo del estor para fijarlo en el **soporte B** hasta que haga «clic».

## 5| Vinculamos el estor

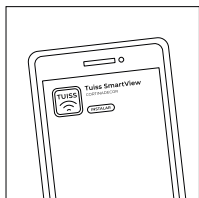

Instalar

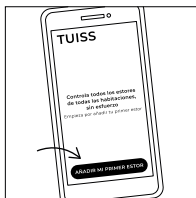

Añadir



Añadir



Escanear

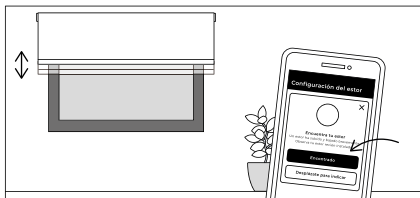

Probar

**Descargamos** la aplicación **Tuiss SmartView** en Apple Store o Google Play Store. Nuestros estores van acompañados de una etiqueta\* con un código QR que **debemos escanear** para conectar los estores a la app.

*\*; **Importante!** Conservar la etiqueta con código QR, por si necesitamos volver a emparejar los estores con la app.*



**Atención al cliente**

[soporte@cortinadecor.com](mailto:soporte@cortinadecor.com)

966 181 033

[www.cortinadecor.com](http://www.cortinadecor.com)